

## General Description

The OIL4060-ST is an infrared LED designed for fiber optic data communications.

The 850 nm wavelength provides operation in 50um, 62,5um, 100um and 200um glass fibers.

Data rate can vary from DC to 50MHz, depending on application.

The optical power grows proportionally with the led current.

The metal ST housing is a robust package suitable for industrial applications.

The OIL4060-ST can be coupled to the receiver OIA4160-ST or different ones



## Features

- High-speed 50MHz
- High power output
- High reliability
- RoHS compliant
- Suitable with 50-100-200um core glass fiber

## Applications

- Data transmission for industrial environment
- Data transmission in factory automation and office
- Industrial LAN and FIELD BUS
- Home and Building Automation

## Pin Functions

| No. | Name | Function                                    |
|-----|------|---|
| 1   | A    | Anode (white marked), not connected to case |
| 2   | K    | Cathode, not connected to case              |

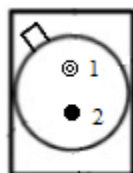

Bottom view, pin #1 is marked

## Ordering information

**OIL4060-ST**      Optical emitter for data communication in ST Metal Case

**ABSOLUTE MAXIMUM RATINGS**

| Symbol    | Parameter  | Min | Max | Unit             |
|-----------|--|-----|-----|------------------|
| $I_F$     | Forward current @ $T_A=25^\circ\text{C}$                                 |     | 60  | mA               |
| $V_R$     | Reverse voltage @ $T_A=25^\circ\text{C}$                                 |     | 3   | V                |
| $I_{FM}$  | Pulsed Forward current (Pulse width = 10 $\mu\text{m}$ , duty cycle 50%) |     | 100 | mA               |
| $T_{opr}$ | Operating temperature  | -40 | 85  | $^\circ\text{C}$ |
| $T_{stg}$ | Storage temperature  | -40 | 100 | $^\circ\text{C}$ |
| $P_D$     | Power Dissipation @ $T_A=25^\circ\text{C}$                               |     | 170 | mW               |
| $T_{Sol}$ | Lead Temperature (solder) 5s at 1mm                                      |     | 260 | $^\circ\text{C}$ |
| MSL       | Moisture Sensitive Level   |     | 1   |                  |

Stresses beyond those listed under "Absolute Maximum Ratings" may cause permanent damage to the device. These are stress ratings only, and functional operation of the device at these or any other conditions beyond those indicated in the operational sections of the specifications is not implied. Exposure to absolute maximum rated conditions for extended periods may affect device reliability.

**ELECTRICAL AND OPTICAL CHARACTERISTICS**

$T_A=25^\circ\text{C}$  and  $I_F=50\text{mA}$  unless otherwise noted.

| Symbol          | Parameter                    | Conditions   | Min | Typ | Max | Unit          |
|-----------------|------------------------------|--|-----|-----|-----|---------------|
| $f_c$           | Cut off frequency            |  | 35  | 50  |     | MHz           |
| $\lambda_p$     | Peak emission wavelength     |  | 850 | 870 | 890 | nm            |
| $\Delta\lambda$ | Spectral half width          |  |     | 35  | 50  | nm            |
| $P_o$           | Fiber coupled output power + | $I_F=10\text{mA}$ 200/230 $\mu\text{m}$ HCS<br>$-40^\circ\text{C} < T_a < 85^\circ\text{C}$ , $\lambda=850\text{nm}$ | 20  | 90  |     | uW            |
|                 |                              | $I_F=20\text{mA}$ 200/230 $\mu\text{m}$ HCS<br>$-40^\circ\text{C} < T_a < 85^\circ\text{C}$ , $\lambda=850\text{nm}$ | 35  | 180 |     |               |
| $V_F$           | Forward voltage              | $I_F=10\text{mA}$  |     | 1.5 |     | V             |
|                 |                              | $I_F=50\text{mA}$  |     | 2   | 2,4 |               |
| $V_{FM}$        | Pulsed Forward voltage       | $I_F=100\text{mA}$   |     | 2,4 | 3,6 |               |
| $I_R$           | Reverse current              | $V_R=3\text{V}$  |     |     | 10  | $\mu\text{A}$ |

+ Typical power is given at  $T_a=25^\circ\text{C}$ , minimum power is guaranteed in the whole temperature range

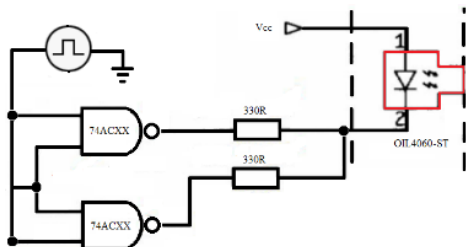
**TYPICAL DRIVING CIRCUIT**

The suggested driving circuit is built using 74ACXX ports.

Connect the pulse generator to the logic port inputs, connect the logic port output to a limiting resistor and then to the cathode of OIL4060.

The anode will be connected to Vcc 5V power supply.

To get 10mA use one channel with 330 Ohm resistor, to get 20mA use two channels with 330 Ohm resistors each.

To increase the led current just use more logic port channels, connected as in the figure.

**MECHANICAL DIMENSIONS**

Units=mm

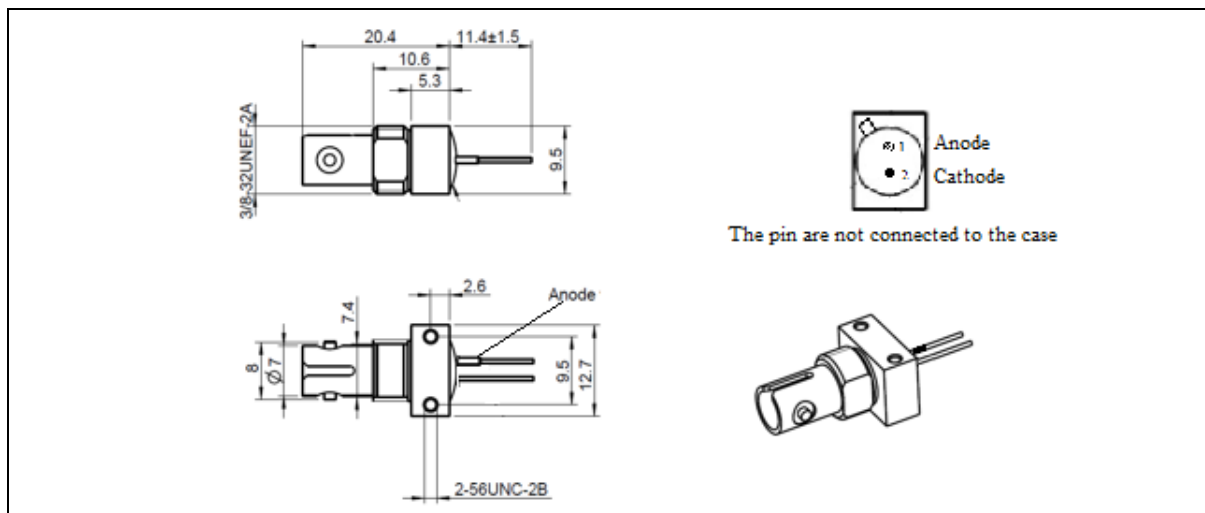

ELECTRICAL AND OPTICAL CHARACTERISTICS

Fiber End Output vs. Ambient Temperature  
(measured with 200/230um HCS fiber 1m)

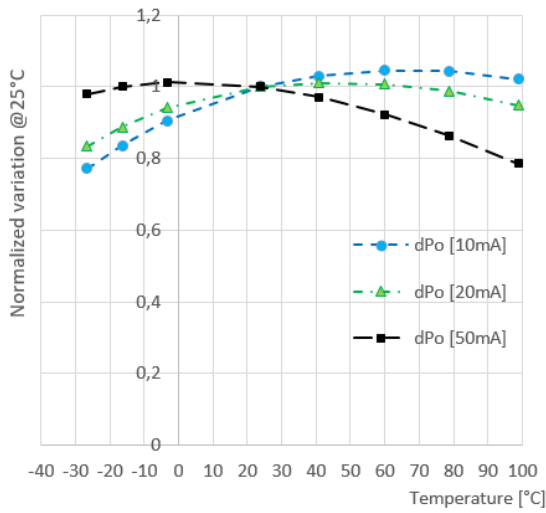

Typical Fiber End Output vs. Forward Current  
(measured with 200/230um HCS fiber 1m, Ta=25°C)

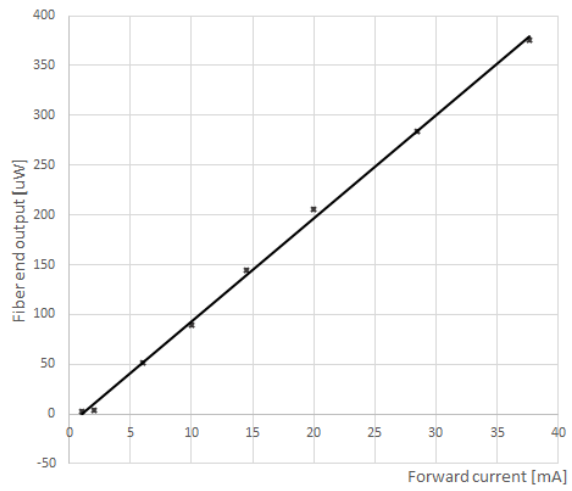

Forward Current vs. Forward Voltage  
[Ta=25°C]

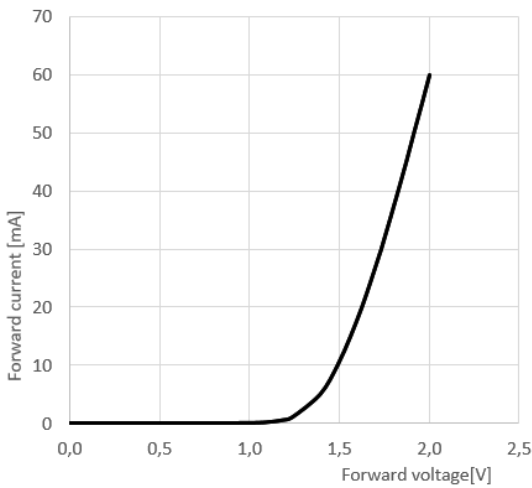

Frequency Characteristic

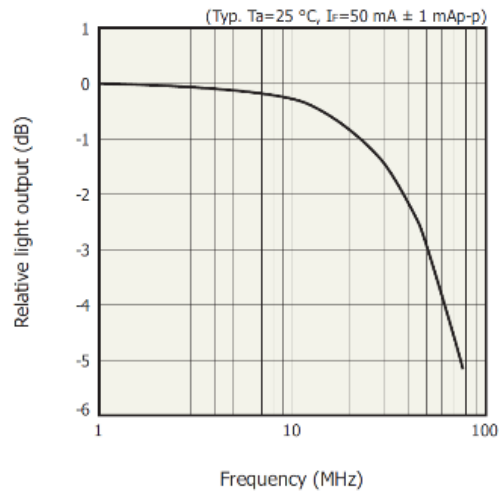

Emission Spectrum

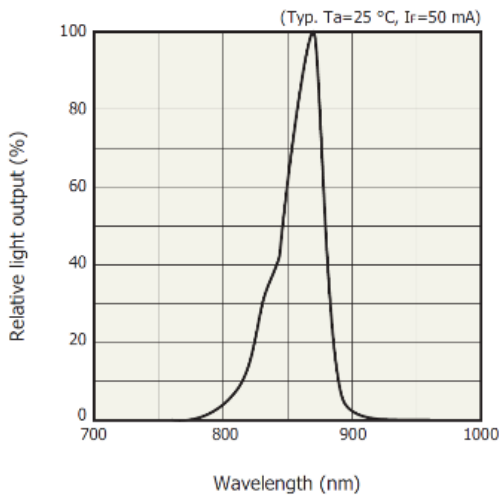

Allowable Typ Forward Current vs. Ambient Temperature

